

# Manitowoc Cranes

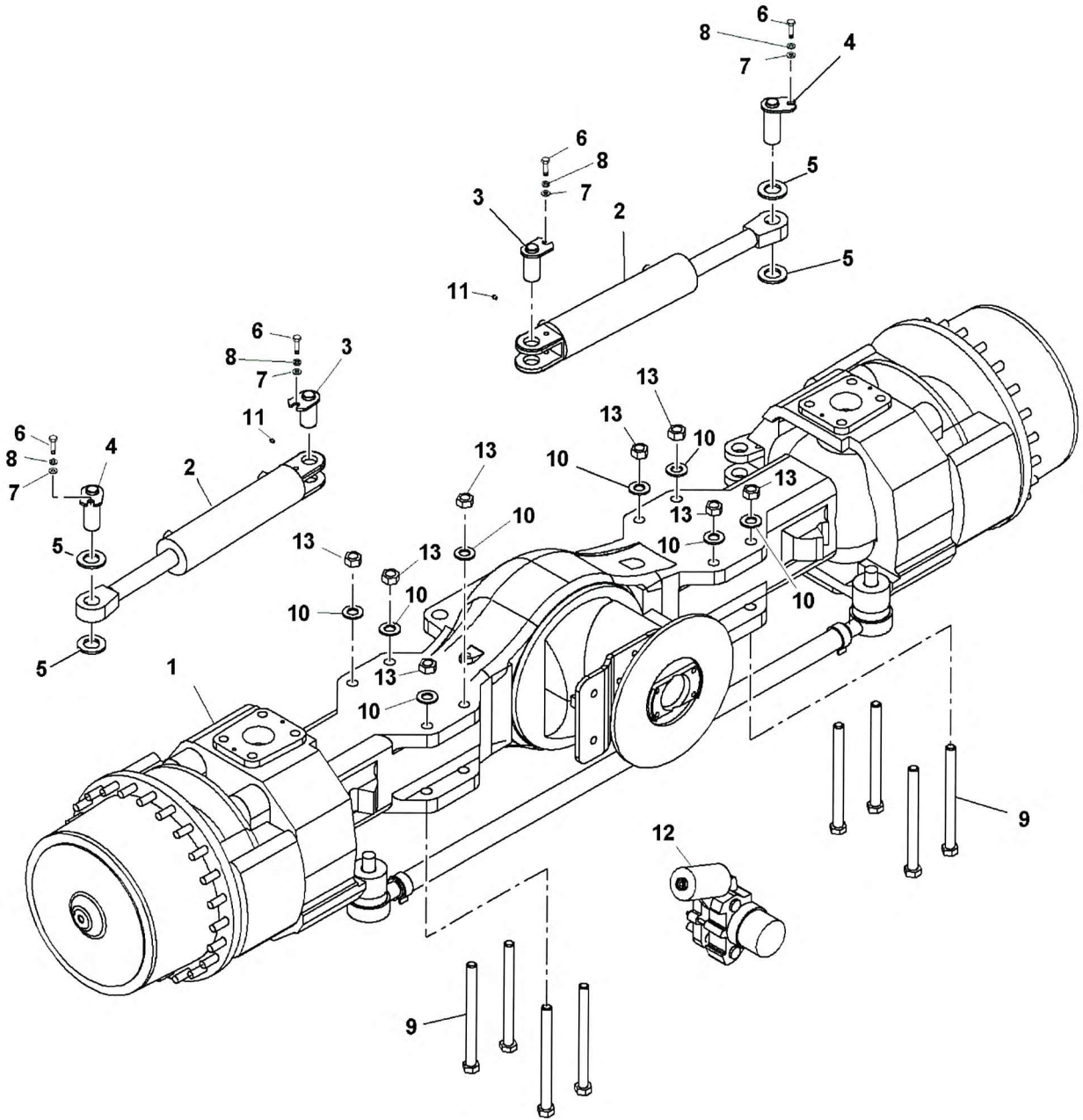

2189510004

(SHEET 1 OF 1)

Page 542